



SYNCHRONOUS ALTERNATORS



www.jcbenergy.es

General Specifications

Jcbenergy, is an independent and internationally recognized power producer, specializing exclusively on manufacturing of synchronous alternators.

Jcbenergy focuses its corporate mission on original and self-made designs; innovative solutions and provide long-term and sustainable development.

Turkish and foreign technical teams are always working with their knowhow and experience in order to meet universal demands and projects and to have a continuous increase in the performance, total lifespan and overall reliability of the products. Jcbenergy continues the R&D studies with universities both in Europe and in other countries who have comprehensive knowledge on its products.



Jcbenergy synchronous alternators are proven to endure the harshest environmental applications. They proved to be one of the most reliable and preferred alternator brands all over the world with their brushless and self-exciting system, electronic voltage regulator (AVR), stable wave form, low harmonic distortion and high efficiency.

In case of a demand, Jcbenergy can also produce direct current (DC) alternators, 50-60 Hz low voltage (LV) alternators, medium voltage alternators, high voltage alternators; alternators for light towers, welding alternators, IP44 and PI54 class alternators for marine applications, variable speed alternators for telecom projects and cranes; high frequency alternators for ground power units, radars, planes and helicopters.

Product Application

Jcbenergy alternators are mainly used in the application of diesel, gasoline and gas generator groups. They are also able to operate with steam or hydraulic turbines. They operate in all configurations of emergency generator groups, power plants or continuous power sources.

- Industrial and commercial complex.
- Telecommunication and cell-phone towers, radio and television transmitters
- Defense industry and military projects.
- Construction sites, mining, stone crushers and mixing plants, light towers
- Agriculture and irrigation; cattle and chicken farms
- Hotels and hospitals, lofts, care centers, clinics
- Offices, shops, factories, workshops, buildings, sports complexes, stores, malls, banks, gas stations
- Rental companies, mobile service vehicles, mobile hospitals, and other mobile facilities
- Airports, initial starting of the air vehicles, ground services

Construction

Jcbenergy alternators are made according to the requirements of the standard TSE 60034-1; IEC 60034-1. Using the best quality standards during manufacturing, the result is safe operation and great durability. Mounting styles normally supplied are; Single bearing with coupling by means of flanges and flexible disc. Double bearing with coupling by means of flange.

Winding & Electrical Performance

All alternators stators windings are 2/3 pitch. This eliminates triple (3rd, 9th, 15th ...) harmonics on the voltage waveform and is found to be the optimum design for trouble-free supply of non-linear loads. The 2/3 pitch design avoids excessive neutral currents sometimes seen with higher winding pitches, when in parallel with the mains. A fully connected damper winding reduces oscillations during paralleling. This winding, with the 2/3 pitch and carefully selected pole and tooth designs, ensures very low waveform distortion. High quality siliceous metals are used in the body and it increases the efficiency of the alternator.

Excitation System & Automatic Voltage Regulators (AVR)

The self-winding control system supplies power from the main stator to the winding stator via AVR. The high efficiency semiconductors of AVR (diodes transmitters, etc.) allow the low permanent voltage to be positively raised. Three-phase excitation rotor diode bridge output supplies the main rotor excitation area. There is a varistor that protects the diode bridge and acts as a plug from shocks that may be short-circuited or similar.

With the Frequency / Voltage ratio (U / F) system, it protects AVR and alternator against low frequency. It provides voltage adjustment opportunity within $\pm 5\%$ limits for external voltage adjustment.

Automatic Voltage Regulators (AVR) are specially designed and catered for both single and parallel running operations for both self-excited and separately excited system (PMG).

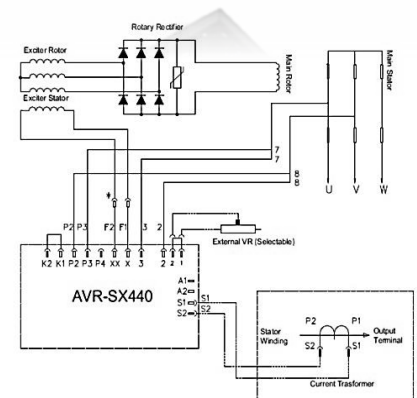

MX 341 + PMG

MX341

Frequency Selection

No link 6P50Hz

4P60Hz

4P60Hz

Stability Selection

> 550KW

90-550KW

< 90KW

Trim

Drop

Volts

Exc. TRIP

Stability Selection

REFER TO GENERATOR WIRING DIAGRAM FOR CONNECTION DETAILS

SUMMARY OF AVR CONTROLS

CONTROL	FUNCTION	DIRECTION
Volts	To adjust generator output voltage	Clockwise Increases output voltage
Stability	To prevent voltage hunting	Clockwise increases the damping effect
Ultra	To set the ultra knee point	Clockwise reduces the knee point frequency
Drop	To set the generator droop to 5% at 0pf	Clockwise increases the droop
Vtrim	To optimise analogue input sensitivity	Clockwise increases the gain or sensitivity
Exc. trip	To set the over excitation cut off level	Clockwise increase the cut off level
Dip	To set the frequency related voltage dip	Clockwise increases the voltage dip

MX 341 + PMG

Terminal & Terminal Box

Standard generators are 3-phase reconnect able with 12 ends brought out to the terminals, which are mounted on a cover at the non-drive end of the generator. A sheet steel terminal box contains the AVR and provides ample space for the customers' wiring and gland arrangements. It has removable panels for easy access.

Insulation / Impregnation (VPI)

The insulation system is class H. All winding components are impregnated in an unsaturated polyester resin of 200 class temperature. The impregnation provides much needed rigidity and protection against the harsh environment, typical for the generators applications.

Jcbenergy alternators are delivered with Jcbenergy insulation system. This insulation system is based on the "Vacuum Pressure Impregnation" (VPI) system which was developed in cooperation with the most renowned suppliers of insulation material all over the world. Using special epoxy based resin; this insulation system ensures perfect winding insulation of the alternators and does not emit harmful gases into the environment.

Dynamic Balancing

The rotating (Main rotor, exciter rotor, diode group, fan) parts are dynamically balanced with greater precision than that required by the Standard TSE EN IEC 60034-14 and ISO2372, ensuring minimum levels of residual unbalance.

Waveforms / Radio Interference

The alternators are designed to give an excellent output waveform. The total harmonic content of line voltage waveform on no load is less than 5% as per limits specified by TSE / IEC Standards. The Alternators are having negligible Radio Frequency Interference and meets the general limits permitted by VDE 0875 (N). TIF value is <50 and THF value is <2%.

Transient Ratings

Transient voltage drop due to application of full load at 0.8 power factor is less than 18% output voltage recovers to within 3% of the rated value in less than 0.3 seconds.

Continuous Duty / S1 – Ambient Temperature / 40°C

The alternator operates at rated power for an unlimited time with the possibility of overload up to 10% for 1 hour every 12 hours, without damage to its insulation system. The S1, also called continuous or prime duty is applied mainly where there is not another power source available, such as; groups for rental groups for irrigation, refrigeration and application for peak hours. For continuous duty, it is accepted a temperature raise in the windings of up to 125°C.

Standby Duty – Ambient Temperature / 40°C

The generator group operates as energy backup with variable loads in emergency situations in places supplied by the grid / utility company or another main power source. In this kind of duty, the machine does not accept overloads and operates with variable loads up to the rated power of the stand-by duty (40°C). A raise in the winding temperature of up to 150°C is accepted (as per Standard of TSE 60034 / IEC 60034), However if that happens the useful life of the alternator reduces 2 to 6 times. The use of the alternator in stand-by duty is limited to 500 hours a year.

Operating Conditions

When choosing an alternator, “ALTITUDE”, “AMBIENT TEMPERATURE” and “POWER FACTOR” should be taken into consideration. Power drops should be calculated with the help of the table below and power determination should be done accordingly.

Altitude

The rated power refers to installations up to 1000 meter above sea level. For applications over this altitude, the following power correction factor must be applied.

Altitude (m)	<1000	<1500	<2000	<2500	<3000
K Factor	1	0.96	0.93	0.90	0.86

Power Factor (Cos Q)

The nominal power factor is 0.8 lagging. For application with power factor value different from 0.8, the following correction factor must be applied.

Power Factor (Cos Q)	0.80	0.70	0.60	0.30	0
K Factor	1	0.93	0.88	0.82	0.80

Ambient Temperature

The rated powers refer to installation with ambient temperature of 40°C. For applications different from 40°C, the following power correction factor must be applied.

Ambient Temperature	30°C	35°C	40°C	45°C	50°C	55°C
K Factor	1.04	1.02	1	0.96	0.93	0.90

Thermal Insulation Class

Insulation class governs the maximum permissible temperature an alternator can operate without damaging the insulation system.

Insulation Class	Maximum Permissible Temperature
F	155 °C
H	180 °C

Temperature Rise

Temperature rise is the increase in temperature above ambient temperature 40°C ratings.

Temperature Rise	Temperature C°
B	80 °C
F	105 °C
H	125 °C

Stand-by application allows windings to run hotter than the class H temperature rise limit, therefore for an ambient of;

40°C Temperature Rise: 150°C

27°C Temperature Rise: 163°C

Generator Set Ratings

Genset Rating	Emergency Standby Power(ESP)	Limited Time Prime Power(LTP)	Prime Rated Power (PRP)	Continuous Operating Power(COP)
Load Type	Variable	Constant	Variable	Constant
Annual Operating Hours	200	500	Unlimited	Unlimited
Average Load	70%	100%	70%	100%
Overload	No	No	10% 1 Hour in Every 12	No
Alternator Rating	Standby	Standby	Continuous	Continuous
Duty Cycle	S10	S10	S1	S1
Alternator Ratings	Standby 150/40°C	Standby 150/40°C	Class H 125/40°	Class H 125/40°
	Standby 163/27°C	Standby 163/27°C	Class H 105/40°	Class H 105/40°

Alternator Technical Data – 50Hz

4 POLE 1500 RPM 50Hz

Typical Data

Insulation Class	H	Control System	Self Excited
Winding Pitch	2/3 - (N° 6)	A.V.R. Model	Standard SX440/MX 321 + PMG
Wires	12	Voltage Regulation	± 1.0 %
Drip Proof	IP 23	Sustained short-circuit current	300% (3 IN) : 10s
Altitude	≤ 1000 m	Total harmonic (*) TGH / THC	< 4 %
Overspeed	2250 min-1	Wave Form: NEMA = TIF - (*)	< 50
Air Flow	1.035 m³/sec	Wave Form: I.E.C. = THF - (*)	< 2 %
Bearing Drive	-	Bearing non-Drive	6314 - 2RZ

(*)Total harmonic content line to line, at no load or full rated linear and balanced load

50 Hz kVA / kW – Power Factor (CosQ) = 0,8

Duty Ambient C°	Continuous / 40 ° C			Standby / 27 ° C			
Class / C° rise	H / 125 ° K			H / 163° K			
Series Star(V)	380/220	400/231	415/240	380/220	400/231	415/240	
Parallel Star (V)	190/110	200/115	208/120	190/110	200/115	208/120	
Series Delta(V)	220	230	240	220	230	240	
JNP 355 S1	kVA	555	555	566	610	610	623
	kW	444	444	453	488	488	498
JNP 355 M	kVA	600	600	612	660	660	673
	kW	480	480	490	528	528	538
JNP 355 M1	kVA	659	659	672	725	725	739
	kW	527	527	538	580	580	591
JNP 355 MX	kVA	700	700	717	770	770	789
	kW	560	560	574	616	616	668
JNP 355 MXA	kVA	750	750	765	825	825	842
	kW	600	600	612	660	660	674
JNP 355 L	kVA	773	773	788	850	850	867
	kW	618	618	630	680	680	694
JNP 355 LX	kVA	850	850	867	935	935	954
	kW	680	680	694	748	748	763

REACTANCES (%) – TIME CONSTANTS (ms) : CLASS: H / 400 V

VOLTAGE SERIAL STAR	400 V	355S1	355M	355M1	355MX	355MXA	355L	355LX
DIR. AXIS SYNCHRONOUS	Xd	2,95	2,72	2,83	2,62	2,58	2,57	2,55
DIR. AXIS TRANSIENT	X'd	0,16	0,14	0,15	0,14	0,14	0,14	0,14
DIR. AXIS SUBTRANSIENT	X''d	0,12	0,1	0,11	0,1	0,1	0,1	0,1
QUAD. AXIS REACTANCE	Xq	2,4	2,24	2,21	2,19	2,18	2,16	2,19
QUAD. AXIS SUBTRANSIENT	X''q	0,24	0,25	0,24	0,23	0,24	0,25	0,23
LEAKAGE REACTANCE	XL	0,06	0,04	0,05	0,04	0,04	0,05	0,04
NEGATIVE SEQUENCE	X2	0,17	0,17	0,16	0,15	0,15	0,15	0,15
ZERO SEQUENCE	X0	0,1	0,09	0,08	0,07	0,065	0,06	0,065

OTHER DATA – CLASS H / 400 V

T'd TRANSIENT TIME CONST.	0,08 s	0,08 s	0,08 s	0,08 s	0,08 s	0,08 s	0,08 s	0,08 s
T''d SUB-TRANSTIME CONST.	0,012 s	0,012 s	0,012 s	0,012 s	0,012 s	0,012 s	0,012 s	0,012 s
T'do O.C. FIELD TIME CONST	2 s	2,2 s	2,5 s	2,5 s	2,5 s	2,5 s	2,5 s	2,5 s
Ta ARMATURE TIME CONST.	0,017 s	0,017 s	0,019 s	0,019 s	0,019 s	0,019 s	0,019 s	0,019 s
SHORT CIRCUIT RATIO	1/Xd	1/Xd	1/Xd	1/Xd	1/Xd	1/Xd	1/Xd	1/Xd

3 Phase / 400V / 50 Hz Efficiency Curves & Percent Transient Voltage Dip & Alternator Windings

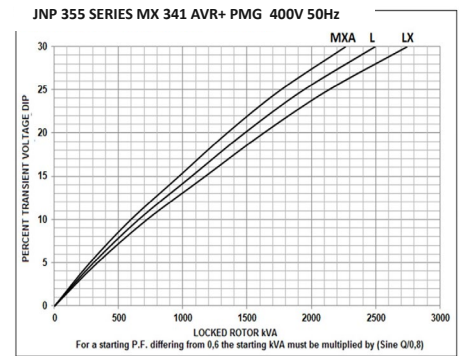
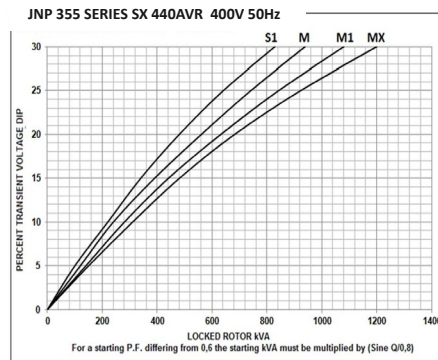
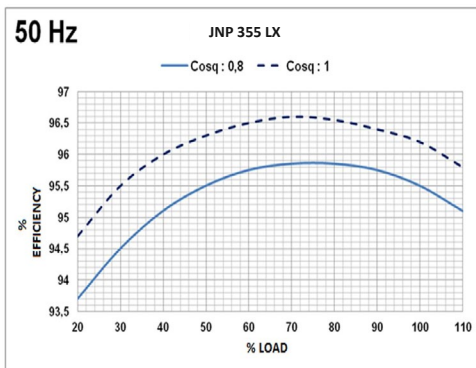
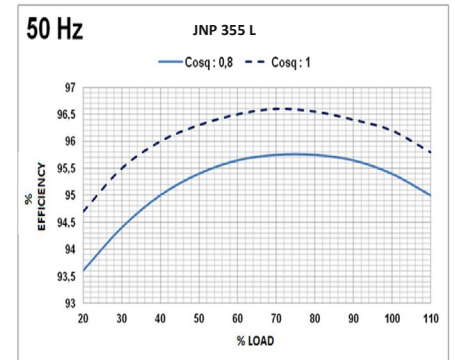
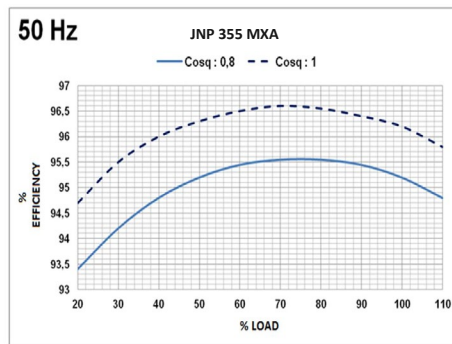
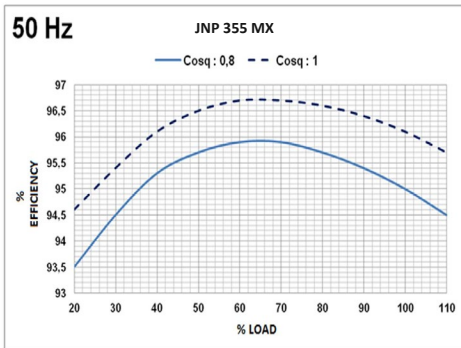
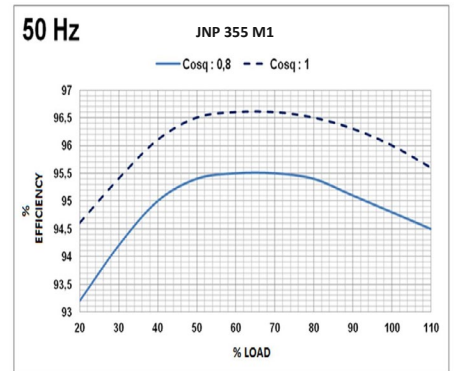
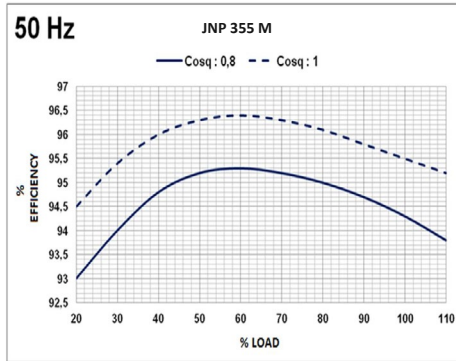
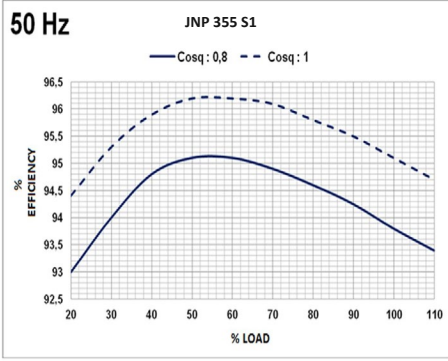

ALTERNATOR WINDINGS							
4 Pole							
50 Hz - 1500 R.P.M							
Phase	3	3	3	3	3	1	1
Connections							
Number of Leads	6	6	12	12	12	12	12
Standard Winding	380 - 400 - 415V	220 - 240V	380 - 400 - 415V	220 - 240V	190 - 208V	220 - 240V	220 - 240V

High quality 100% copper wires are used in the rotors, stators and excitation wirings of JCBENERGY alternators. All metal sheets used in the production are siliceous metals. Therefore, JNP alternators have higher efficiency compared to exemplary products.

Alternator Technical Data – 60Hz

4 POLE 1800 RPM 60 Hz

Typical Data

Insulation Calss	H	Control system	Self excited
Winding Pitch	2/3 - (N° 6)	A.V.R. model	Standard SX440/MX341+PMG
Wires	12	Voltage regulation	± 1.0 %
Drip Proof	IP 23	Sustained short-circuit current	300% (3 IN) : 10s
Altitude	≤ 1000 m	Total harmonic (*) TGH / THC	< 5 %
Overspeed	2250 min-1	Wave form: NEMA = TIF - (*)	< 50
Air Flow	1.312 m³/sec.	Wave form: I.E.C. = THF - (*)	< 2 %
Bearing Drive	-	Bearing non-drive	6314 - 2RZ

(*)Total harmonic content line to line, at no load or full rated linear and balanced load

60 Hz kVA / kW – Power Factor (CosQ) = 0,8

Duty Ambient C°		Continuous / 40 ° C			Standby / 27 ° C		
		H / 125 ° K			H / 163 ° K		
Class / C° rise							
Series Star(V)		416/240	440/254	480/277	416/240	440/254	480/277
Parallel Star (V)		208/120	220/127	240/138	208/120	220/127	240/138
Series Delta(V)		240	254	277	240	254	277
JNP 355 S1	kVA	661	696	733	727	766	806
	kW	529	557	586	582	613	645
JNP 355 M	kVA	697	734	773	767	807	850
	kW	558	587	618	614	646	680
JNP 355 M1	kVA	743	782	824	817	860	906
	kW	594	626	659	654	688	725
JNP 355 MX	kVA	789	831	875	868	914	963
	kW	631	665	700	694	731	770
JNP 355 MXA	kVA	846	891	938	931	980	1032
	kW	677	713	750	745	784	826
JNP 355 L	kVA	865	911	956	951	1002	1055
	kW	692	729	767	761	802	844
JNP 355 LX	kVA	945	995	1047	1040	1095	1152
	kW	756	796	838	832	876	922

REACTANCES (%) – TIME CONSTANTS (ms) : CLASS: H / 480 V

	480V	355S1	355M	355M1	355MX	355MXA	355L	355LX
VOLTAGE SERIAL STAR								
DIR. AXIS SYNCHRONOUS	Xd	3,0975	2,856	2,9715	2,751	2,709	2,6985	2,6775
DIR. AXIS TRANSIENT	X'd	0,168	0,147	0,1575	0,147	0,147	0,147	0,147
DIR. AXIS SUBTRANSIENT	X''d	0,126	0,105	0,1155	0,105	0,105	0,105	0,105
QUAD. AXIS REACTANCE	Xq	2,52	2,352	2,3205	2,2995	2,289	2,268	2,2995
QUAD. AXIS SUBTRANSIENT	X''q	0,252	0,2625	0,252	0,2415	0,252	0,2625	0,2415
LEAKAGE REACTANCE	XL	0,063	0,042	0,0525	0,042	0,042	0,0525	0,042
NEGATIVE SEQUENCE	X2	0,1785	0,1785	0,168	0,1575	0,1575	0,1575	0,1575
ZERO SEQUENCE	X0	0,105	0,0945	0,084	0,0735	0,06825	0,063	0,06825

OTHER DATA – CLASS H / 480V

VOLTAGE SERIAL STAR	355S1	355M	355M1	355MX	355MXA	355L	355LX
T'd TRANSIENT TIME CONST.	0,08 s	0,08 s	0,08 s	0,08 s	0,08 s	0,08 s	0,08 s
T''d SUB-TRANSTIME CONST.	0,012 s	0,012 s	0,012 s	0,012 s	0,012 s	0,012 s	0,012 s
T'do O.C. FIELD TIME CONST	2 s	2,2 s	2,5 s	2,5 s	2,5 s	2,5 s	2,5 s
Ta ARMATURE TIME CONST.	0,017 s	0,0017 s	0,019 s	0,019 s	0,019 s	0,019 s	0,019 s
SHORT CIRCUIT RATIO	1/Xd	1/Xd	1/Xd	1/Xd	1/Xd	1/Xd	1/Xd

3 Phase / 480V / 60 Hz Efficiency Curves & Percent Transient Voltage Dip & Alternator Windings

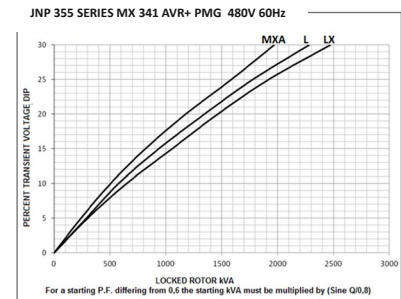
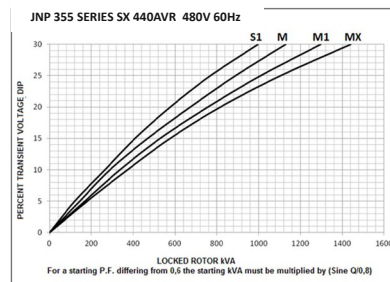
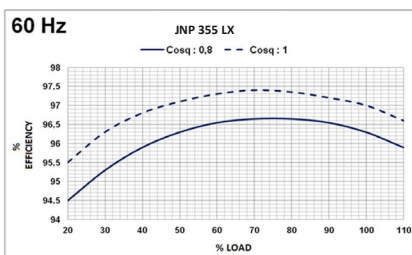
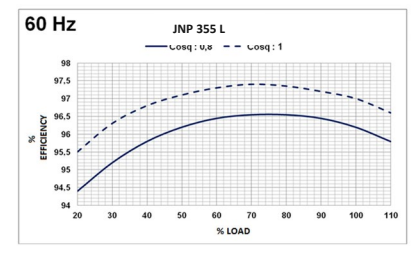
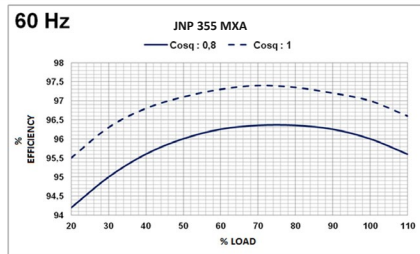
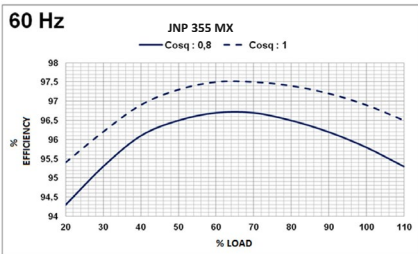
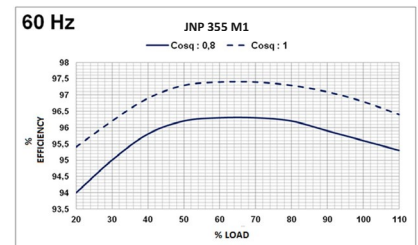
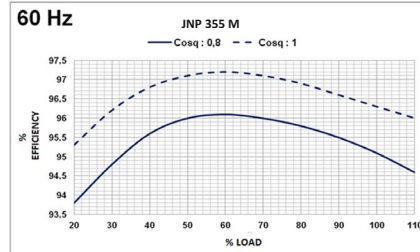
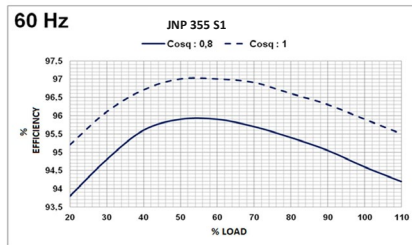

ALTERNATOR WINDINGS						
4 Pole	60 Hz - 1800 R.P.M					
Phase	3	3	3	3	3	1
Connections						
Number of Leads	6	6	12	12	12	12
Standard Winding	380 - 480V	220 - 277V	380 - 480V	220 - 277V	190 - 240V	220 - 240V

High quality 100% copper wires are used in the rotors, stators and excitation wirings of JCBENERGY alternators. All metal sheets used in the production are siliceous metals. Therefore, JNP alternators have higher efficiency compared to exemplary products.

DIMENSIONS

Connection Type		Size					Coupling Disc					
SAE	MODEL	C-G	K	L	M	N	SAE	AN	AR	AS	AT	V
1	355 S1-S2	555	1337	1266	568	493	14	25,4	8	13,5	438,1	466,6
	355 M-M1	575	1337	1266	568	493	Flange Adapter					
	355MX-MXA	595	1337	1266	568	583	SAE	R	S	T	W	X
	315L-LX	620	1412	1341	643	583	1	12	12,7	530,2	496	511,1

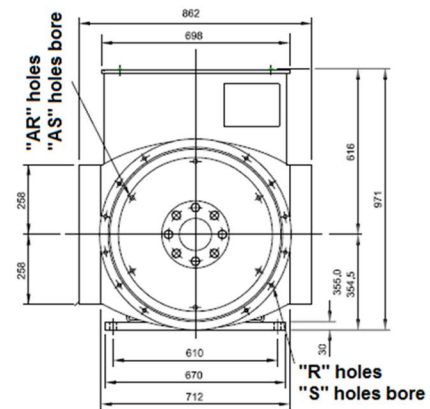
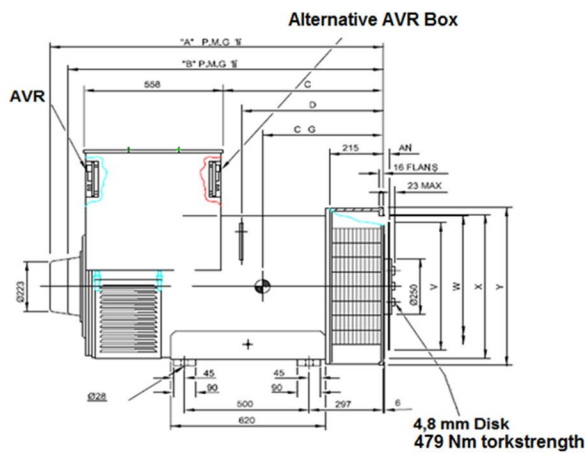

Special Products / Non - Standardized

Light Tower Alternators

Welding Alternators

High Frequency Alternators

Variable Speed Alternators

Direct Current Alternators - (DC)

Medium Voltage Alternators - (MV)

High Voltage Alternators - (HV)

IP44 and IP54 Class Alternators - (Marine)



www.jcbenergy.es