



SYNCHRONOUS ALTERNATORS



www.jcbenergy.es

General Specifications

Jcbenergy, is an independent and internationally recognized power producer, specializing exclusively on manufacturing of synchronous alternators.

Jcbenergy focuses its corporate mission on original and self-made designs; innovative solutions and provide long-term and sustainable development.

Turkish and foreign technical teams are always working with their knowhow and experience in order to meet universal demands and projects and to have a continuous increase in the performance, total lifespan and overall reliability of the products. Jcbenergy continues the R&D studies with universities both in Europe and in other countries who have comprehensive knowledge on its products.



Jcbenergy synchronous alternators are proven to endure the harshest environmental applications. They proved to be one of the most reliable and preferred alternator brands all over the world with their brushless and self-exciting system, electronic voltage regulator (AVR), stable wave form, low harmonic distortion and high efficiency.

In case of a demand, Jcbenergy can also produce direct current (DC) alternators, 50-60 Hz low voltage (LV) alternators, medium voltage alternators, high voltage alternators; alternators for light towers, welding alternators, IP44 and PI54 class alternators for marine applications, variable speed alternators for telecom projects and cranes; high frequency alternators for ground power units, radars, planes and helicopters.

Product Application

Jcbenergy alternators are mainly used in the application of diesel, gasoline and gas generator groups. They are also able to operate with steam or hydraulic turbines. They operate in all configurations of emergency generator groups, power plants or continuous power sources.

- Industrial and commercial complex.
- Telecommunication and cell-phone towers, radio and television transmitters
- Defense industry and military projects.
- Construction sites, mining, stone crushers and mixing plants, light towers
- Agriculture and irrigation; cattle and chicken farms
- Hotels and hospitals, lofts, care centers, clinics
- Offices, shops, factories, workshops, buildings, sports complexes, stores, malls, banks, gas stations
- Rental companies, mobile service vehicles, mobile hospitals, and other mobile facilities
- Airports, initial starting of the air vehicles, ground services

Construction

Jcbenergy alternators are made according to the requirements of the standard TSE 60034-1; IEC 60034-1. Using the best quality standards during manufacturing, the result is safe operation and great durability. Mounting styles normally supplied are; Single bearing with coupling by means of flanges and flexible disc. Double bearing with coupling by means of flange.

Winding & Electrical Performance

All alternators stators windings are 2/3 pitch. This eliminates triple (3rd, 9th, 15th ...) harmonics on the voltage waveform and is found to be the optimum design for trouble-free supply of non-linear loads. The 2/3 pitch design avoids excessive neutral currents sometimes seen with higher winding pitches, when in parallel with the mains. A fully connected damper winding reduces oscillations during paralleling. This winding, with the 2/3 pitch and carefully selected pole and tooth designs, ensures very low waveform distortion. High quality siliceous metals are used in the body and it increases the efficiency of the alternator.

Excitation System & Automatic Voltage Regulators (AVR)

The self-warming control system supplies power from the main stator to the warning stator via AVR. The high efficiency semiconductors of AVR (diodes transmitters, etc.) allow the low permanent voltage to be positively raised. Three-phase excitation rotor diode bridge output supplies the main rotor excitation area. There is a varistor that protects the diode bridge and acts as a plug from shocks that may be short-circuited or similar.

With the Frequency / Voltage ratio (U / F) system, it protects AVR and alternator against low frequency. It provides voltage adjustment opportunity within $\pm 5\%$ limits for external voltage adjustment.

Automatic Voltage Regulators (AVR) are specially designed and catered for both single and parallel running operations for both self-excited and separately excited system (PMG).

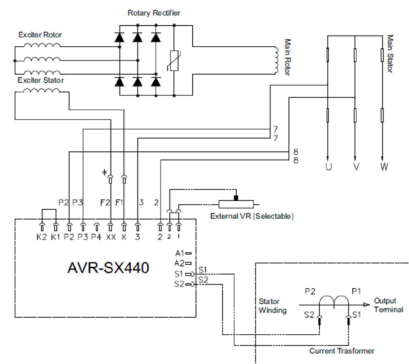
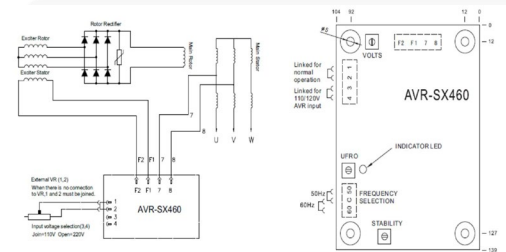

Terminal & Terminal Box

Standard generators are 3-phase reconnect able with 12 ends brought out to the terminals, which are mounted on a cover at the non-drive end of the generator. A sheet steel terminal box contains the AVR and provides ample space for the customers' wiring and gland arrangements. It has removable panels for easy access.

Insulation / Impregnation (VPI)

The insulation system is class H. All winding components are impregnated in an unsaturated polyester resin of 200 class temperature. The impregnation provides much needed rigidity and protection against the harsh environment, typical for the generators applications.

Jcbenergy alternators are delivered with Jcbenergy insulation system. This insulation system is based on the "Vacuum Pressure Impregnation" (VPI) system which was developed in cooperation with the most renowned suppliers of insulation material all over the world. Using special epoxy based resin; this insulation system ensures perfect winding insulation of the alternators and does not emit harmful gases into the environment.

Dynamic Balancing

The rotating (Main rotor, exciter rotor, diode group, fan) parts are dynamically balanced with greater precision than that required by the Standard TSE EN IEC 60034-14 and ISO2372, ensuring minimum levels of residual unbalance.

Waveforms / Radio Interference

The alternators are designed to give an excellent output waveform. The total harmonic content of line voltage waveform on no load is less than 5% as per limits specified by TSE / IEC Standards. The Alternators are having negligible Radio Frequency Interference and meets the general limits permitted by VDE 0875 (N). TIF value is <50 and THF value is <2%.

Transient Ratings

Transient voltage drop due to application of full load at 0.8 power factor is less than 18% output voltage recovers to within 3% of the rated value in less than 0.3 seconds.

Continuous Duty / S1 – Ambient Temperature / 40°C

The alternator operates at rated power for an unlimited time with the possibility of overload up to 10% for 1 hour every 12 hours, without damage to its insulation system. The S1, also called continuous or prime duty is applied mainly where there is not another power source available, such as; groups for rental groups for irrigation, refrigeration and application for peak hours. For continuous duty, it is accepted a temperature raise in the windings of up to 125°C.

Standby Duty – Ambient Temperature / 40°C

The generator group operates as energy backup with variable loads in emergency situations in places supplied by the grid / utility company or another main power source. In this kind of duty, the machine does not accept overloads and operates with variable loads up to the rated power of the stand-by duty (40°C). A raise in the winding temperature of up to 150°C is accepted (as per Standard of TSE 60034 / IEC 60034), However if that happens the useful life of the alternator reduces 2 to 6 times. The use of the alternator in stand-by duty is limited to 500 hours a year.

Operating Conditions

When choosing an alternator, “ALTITUDE”, “AMBIENT TEMPERATURE” and “POWER FACTOR” should be taken into consideration. Power drops should be calculated with the help of the table below and power determination should be done accordingly.

Altitude

The rated power refers to installations up to 1000 meter above sea level. For applications over this altitude, the following power correction factor must be applied.

Altitude (m)	<1000	<1500	<2000	<2500	<3000
K Factor	1	0.96	0.93	0.90	0.86

Power Factor (Cos Q)

The nominal power factor is 0.8 lagging. For application with power factor value different from 0.8, the following correction factor must be applied.

Power Factor (Cos Q)	0.80	0.70	0.60	0.30	0
K Factor	1	0.93	0.88	0.82	0.80

Ambient Temperature

The rated powers refer to installation with ambient temperature of 40°C. For applications different from 40°C, the following power correction factor must be applied.

Ambient Temperature	30°C	35°C	40°C	45°C	50°C	55°C
K Factor	1.04	1.02	1	0.96	0.93	0.90

Thermal Insulation Class

Insulation class governs the maximum permissible temperature an alternator can operate without damaging the insulation system.

Insulation Class	Maximum Permissible Temperature
F	155 °C
H	180 °C

Temperature Rise

Temperature rise is the increase in temperature above ambient temperature 40°C ratings.

Temperature Rise	Temperature C°
B	80 °C
F	105 °C
H	125 °C

Stand-by application allows windings to run hotter than the class H temperature rise limit, therefore for an ambient of;

40°C Temperature Rise: 150°C

27°C Temperature Rise: 163°C

Generator Set Ratings

Genset Rating	Emergency Standby Power(ESP)	Limited Time Prime Power(LTP)	Prime Rated Power (PRP)	Continuous Operating Power(COP)
Load Type	Variable	Constant	Variable	Constant
Annual Operating Hours	200	500	Unlimited	Unlimited
Average Load	70%	100%	70%	100%
Overload	No	No	10% 1 Hour in Every 12	No
Alternator Rating	Standby	Standby	Continuous	Continuous
Duty Cycle	S10	S10	S1	S1
Alternator Ratings	Standby 150/40°C	Standby 150/40°C	Class H 125/40°	Class H 125/40°
	Standby 163/27°C	Standby 163/27°C	Class H 105/40°	Class H 105/40°

Alternator Technical Data – 50Hz

4 POLE 1500 RPM 50Hz

Typical Data

Insulation Class	H	Control System	Self Excited
Winding Pitch	2/3 - (N° 6)	A.V.R. Model	Standard SX460
Wires	12	Voltage Regulation	± 1.0 %
Drip Proof	IP 23	Sustained short-circuit current	300% (3 IN) : 10s
Altitude	≤ 1000 m	Total harmonic (*) TGH / THC	< 5 %
Overspeed	2250 min-1	Wave Form: NEMA = TIF - (*)	< 50
Air Flow	0.095 m³/sec	Wave Form: I.E.C. = THF - (*)	< 2 %
Bearing Drive	-	Bearing non-Drive	6306 - 2RZ

(*)Total harmonic content line to line, at no load or full rated linear and balanced load

50 Hz kVA / kW – Power Factor (CosQ) = 0,8

Duty Ambient C°	Continuous / 40 ° C				Standby / 27 ° C				
Class / C° rise	H / 125 ° K				H / 163° K				
Series Star(V)	380/220	400/231	415/240	1 Ph	380/220	400/231	415/240	1 Ph	
Parallel Star (V)	190/110	200/115	208/120	220	190/110	200/115	208/120	220	
Series Delta(V)	220	230	240	230	220	230	240	230	
JNP 180 M	kVA	24	24	25	16	26	26	28	18
	kW	19	19	20	13	21	21	22	14
JNP 180 M1	kVA	27	27	28	18	30	30	31	20
	kW	22	22	22	14	24	24	25	16
JNP 180 M2	kVA	31	31	32	21	34	34	35	23
	kW	25	25	26	17	27	27	28	18
JNP 180 MX	kVA	35	35	36	23	38	38	40	25
	kW	28	28	29	19	30	30	32	20
JNP 180 L	kVA	40	40	42	27	44	44	26	29
	kW	32	32	34	22	35	35	37	23
JNP 180 LX	kVA	46	46	48	31	51	51	53	34
	kW	37	37	38	25	41	41	42	27
JNP 180 LXA	kVA	50	50	52	33	55	55	57	36
	kW	40	40	42	26	44	44	46	29

REACTANCES (%) – TIME CONSTANTS (ms) : CLASS: H / 400 V

VOLTAGE SERIAL STAR	400 V	180 M	180 M1-M2	180 MX	180 L-LX	180 LXA
DIR. AXIS SYNCHRONOUS	Xd	1,68	1,57	1,995	2,038	2,051
DIR. AXIS TRANSIENT	X'd	0,171	0,15	0,153	0,155	0,156
DIR. AXIS SUBTRANSIENT	X''d	0,111	0,111	0,095	0,087	0,085
QUAD. AXIS REACTANCE	Xq	0,84	0,78	0,967	0,99	0,992
QUAD. AXIS SUBTRANSIENT	X''q	0,19	0,17	0,168	0,075	0,173
LEAKAGE REACTANCE	XL	0,069	0,063	0,061	0,065	0,066
NEGATIVE SEQUENCE	X2	0,161	0,141	0,129	0,132	0,13
ZERO SEQUENCE	X0	0,08	0,068	0,045	0,065	0,064

OTHER DATA – CLASS H / 400 V

T'd TRANSIENT TIME CONST.	0.02s	0.024s	0.024 s	0.025s	0.025s
T''d SUB-TRANSTIME CONST.	0.005s	0.065s	0.015s	0.017s	0.016s
T'do O.C. FIELD TIME CONST	0.4s	0.5 s	0.58s	0,59s	0.57s
Ta ARMATURE TIME CONST.	0.006s	0.007	0.012s	0.011s	0.105s
SHORT CIRCUIT RATIO	1/Xd	1/Xd	1/Xd	1/Xd	1/Xd

3 Phase / 400V / 50 Hz Efficiency Curves & Percent Transient Voltage Dip & Alternator Windings

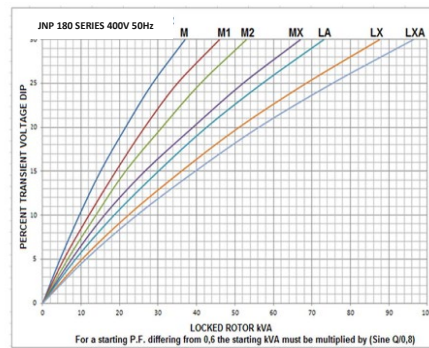
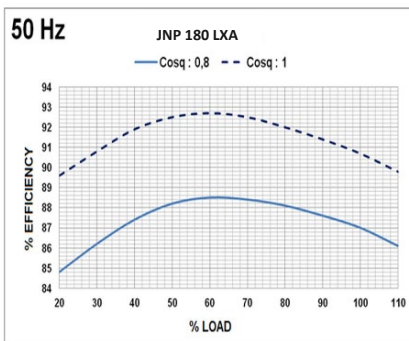
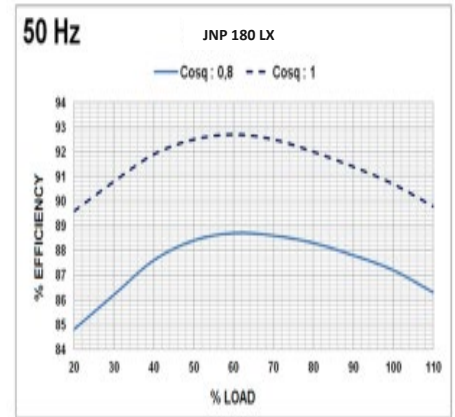
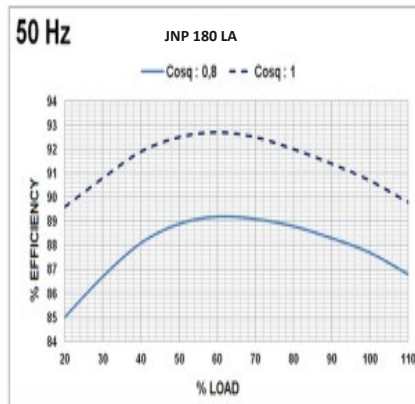
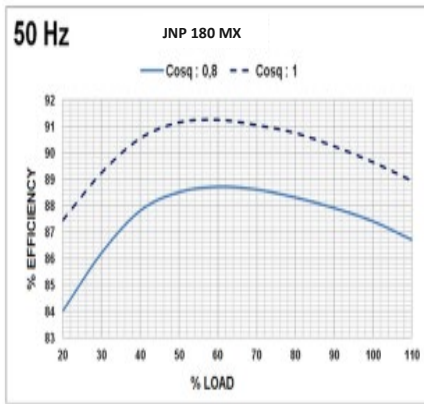
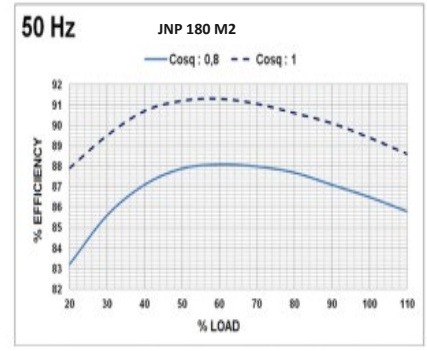
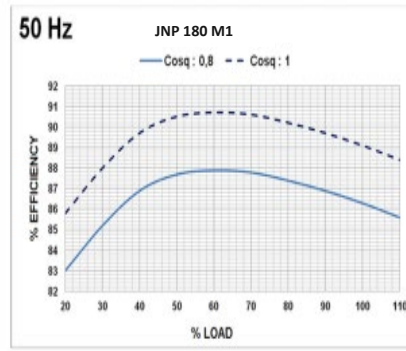
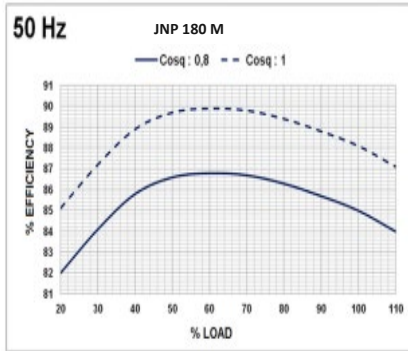

ALTERNATOR WINDINGS							
50 Hz - 1500 R.P.M							
4 Pole	3	3	3	3	3	1	1
Phase							
Connections							
Number of Leads	6	6	12	12	12	12	12
Standard Winding	380 - 400 - 415V	220 - 240V	380 - 400 - 415V	220 - 240V	190 - 208V	220 - 240V	220 - 240V

High quality 100% copper wires are used in the rotors, stators and excitation wirings of JCBENERGY alternators. All metal sheets used in the production are siliceous metals. Therefore, JNP alternators have higher efficiency compared to exemplary products.

Alternator Technical Data – 60Hz

4 POLE 1800 RPM 60 Hz

Typical Data

Insulation Class	H	Control system	Self excited
Winding Pitch	2/3 - (N° 6)	A.V.R. model	Standard SX460
Wires	12	Voltage regulation	± 1.0 %
Drip Proof	IP 23	Sustained short-circuit current	300% (3 IN) : 10s
Altitude	≤ 1000 m	Total harmonic (*) TGH / THC	< 5 %
Overspeed	2250 min-1	Wave form: NEMA = TIF - (*)	< 50
Air Flow	0.119 m³/sec.	Wave form: I.E.C. = THF - (*)	< 2 %
Bearing Drive	-	Bearing non-drive	6306 - 2RZ

(*)Total harmonic content line to line, at no load or full rated linear and balanced load

60 Hz kVA / kW – Power Factor (CosQ) = 0,8

Duty Ambient C°	Continuous / 40 ° C				Standby / 27 ° C				
Class / C° rise	H / 125 ° K				H / 163 ° K				
Series Star (V)	416/240	440/254	480/277	1 Ph	416/240	440/254	480/277	1 Ph	
Parallel Star (V)	208/120	220/127	240/138	-	208/120	220/127	240/138	-	
Series Delta(V)	240	254	277	240	240	254	277	240	
JNP 180 M	kVA	28	30	30	20	31	33	33	22
	kW	22	24	24	16	25	26	26	18
JNP 180 M1	kVA	34	36	36	24	37	40	40	26
	kW	27	29	29	19	30	32	32	21
JNP 180 M2	kVA	38	40	40	27	42	44	44	49
	kW	30	32	32	22	34	35	35	23
JNP 180 MX	kVA	42	45	45	30	46	50	50	33
	kW	34	36	36	24	37	40	40	26
JNP 180 L	kVA	45	48	48	32	50	53	53	35
	kW	36	38	38	26	40	42	42	28
JNP 180 LX	kVA	57	61	61	41	63	67	67	45
	kW	46	49	49	33	50	54	54	36
JNP 180 LXA	kVA	58	63	63	42	64	69	69	46
	kW	46	50	50	34	51	55	55	37

REACTANCES (%) – TIME CONSTANTS (ms) : CLASS: H / 480 V

	480 V	180M	180M1-M2	180MX	180L- LX	180LXA
VOLTAGE SERIAL STAR						
DIR. AXIS SYNCHRONOUS	Xd	1,764	1,649	2,095	2,14	2,154
DIR. AXIS TRANSIENT	X'd	0,18	0,158	0,161	0,163	0,164
DIR. AXIS SUBTRANSIENT	X''d	0,117	0,117	0,1	0,191	0,089
QUAD. AXIS REACTANCE	Xq	0,882	0,819	1,015	1,04	1,042
QUAD. AXIS SUBTRANSIENT	X''q	0,2	0,179	0,176	0,184	0,182
LEAKAGE REACTANCE	XL	0,072	0,066	0,064	0,067	0,069
NEGATIVE SEQUENCE	X2	0,169	0,148	0,135	0,139	0,137
ZERO SEQUENCE	X0	0,084	0,071	0,73	0,068	0,067

OTHER DATA – CLASS H / 480 V

VOLTAGE SERIAL STAR	180M	180M1-M2	180MX	180L- LX	180LXA
T'd TRANSIENT TIME CONST.	0,02s	0.024 s	0.024 s	0.025 s	0.025 s
T'd SUB-TRANSTIME CONST.	0,005s	0,0065	0,0015s	0.017 s	0.016 s
T'do O.C. FIELD TIME CONST.	0,4s	0.5 s	0,58s	0.59 s	0.57 s
Ta ARMATURE TIME CONST.	0,006s	0,007	0,0012s	0.011 s	0.105 s
SHORT CIRCUIT RATIO	1/Xd	1/Xd	1/Xd	1/Xd	1/Xd

3 Phase / 480V / 60 Hz Efficiency Curves & Percent Transient Voltage Dip & Alternator Windings

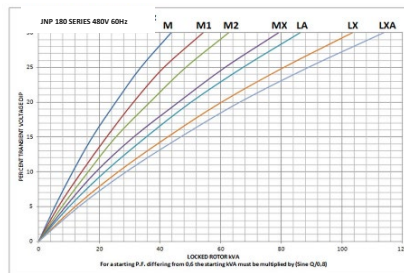
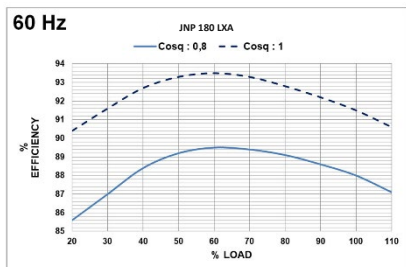
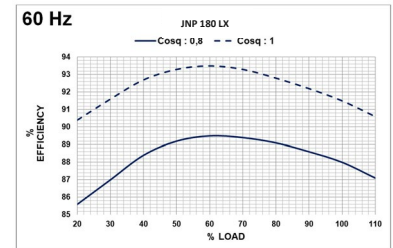
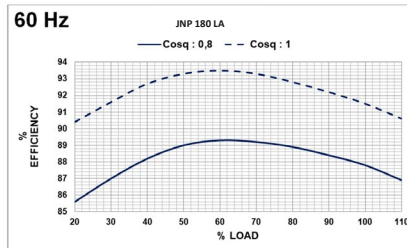
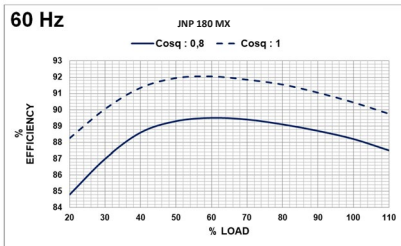
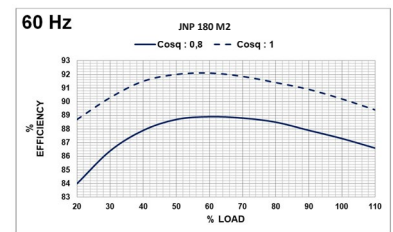
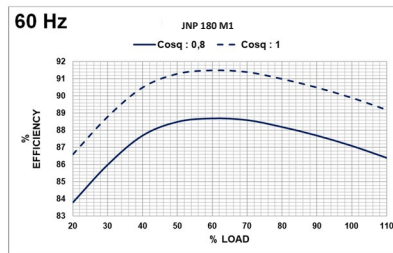
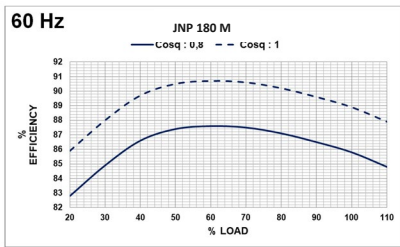

ALTERNATOR WINDINGS						
4 Pole	60 Hz - 1800 R.P.M					
	3	3	3	3	3	1
Phase	3	3	3	3	3	1
Connectors						
Number of Leads	6	6	12	12	12	12
Standard Windings	380-480V	220-277V	380-480V	220-277V	110-240V	220-240V

High quality 100% copper wires are used in the rotors, stators and excitation wirings of JCBENERGY alternators. All metal sheets used in the production are siliceous metals. Therefore, JNP alternators have higher efficiency compared to exemplary products.

DIMENSIONS

Connection Type		Size	Coupling Disc						
SAE	MODEL	A	B	SAE	AN	AM	AP	AR	V
4	180 M-MX	433,5	157	7,5	30,16	8	8.7	222,2	241,2
	180 LA-LXA	523,5	247						
3	180 M-MX	433,5	147	11,5	39,68	8	11	333,4	352,3
	180 LA-LXA	523,5	237						

Flange Adapter

SAE	AW	R	S	T	U	W	X	C	Y
4	95	12	11	381	15	361,9	402	203	201
3	105			428,6		409,5	451	213	225,5

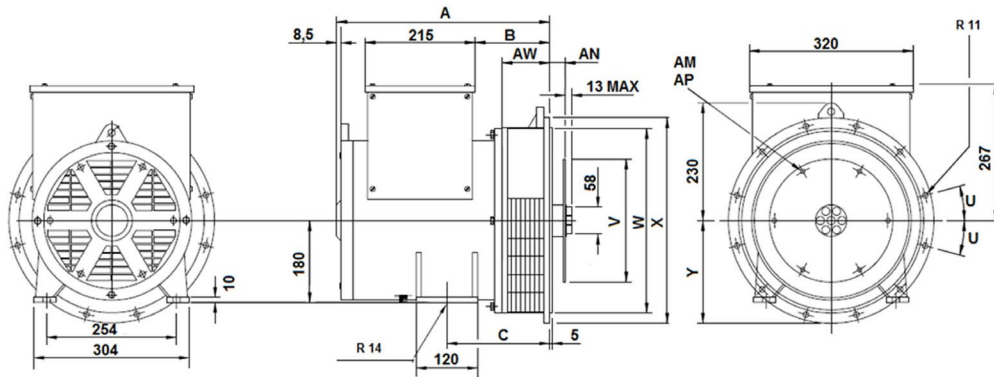

Special Products / Non - Standardized

Light Tower Alternators

Welding Alternators

High Frequency Alternators

Variable Speed Alternators

Direct Current Alternators - (DC)

Medium Voltage Alternators - (MV)

High Voltage Alternators - (HV)

IP44 and IP54 Class Alternators - (Marine)



www.jcbenergy.es